



2430D

Long Snipe Nose Pliers with Monomaterial Handles and Phosphate Finish



PRODUCT DETAILS

- Polypropylene handles
- Cutting capacity: 2.5 mm to 3 mm copper, 1.8 mm iron, 1.4 mm to 1.6 mm iron alloy
- Half-round serrated jaws for gripping flat and round material with great accessibility in confined spaces
- Straight jaws with hardened cutting edges for cutting soft and hard wire
- High-performance alloy steel
- Phosphate finish, anti-corrosion treated
- Standards: ISO 5745
- IP = Industrial packaging

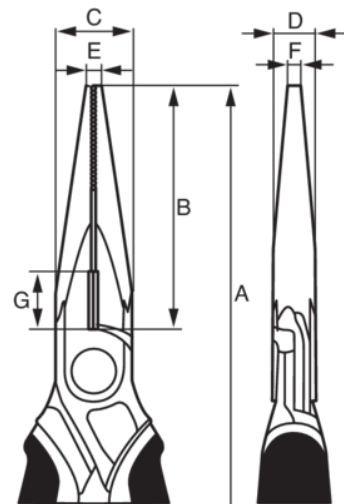





Follow the Fish!







PRODUCT ATTRIBUTES





Product: 2430 D-140

A	140 mm	B	37 mm	C	15 mm
D	7.8 mm	E	2.5 mm	F	2 mm
G	12 mm	 2.5 mm	 1.8 mm		
 1.4 mm	 120 g				





Product: 2430 D-160

A	160 mm	B	51 mm	C	16.5 mm
D	8.8 mm	E	3 mm	F	2.5 mm
G	12 mm	 3.0 mm	 1.8 mm		
 1.6 mm	 160 g				





Product: 2430 D-200

A	200 mm	B	72 mm	C	17 mm
D	9.3 mm	E	3 mm	F	2.5 mm
G	12 mm	 3.0 mm	 1.8 mm		
 1.6 mm	 170 g				





Product: 2430 D-140 IP

A	140 mm	B	37 mm	C	15 mm
D	7.8 mm	E	2.5 mm	F	2 mm
G	12 mm	 2.5 mm	 1.8 mm		
 1.4 mm	 120 g				

Product: 2430 D-160 IP

A	160 mm	B	51 mm	C	16.5 mm
D	8.8 mm	E	3 mm	F	2.5 mm
G	12 mm	 3.0 mm	 1.8 mm		
 1.6 mm	 160 g				

Product: 2430 D-200 IP

A	200 mm	B	72 mm	C	17 mm
D	9.3 mm	E	3 mm	F	2.5 mm
G	12 mm	 3.0 mm	 1.8 mm		
 1.6 mm	 170 g				

