

PY20 1150x540

SCALE PALLET TRUCK 2000 KG



The PY20 is the easy-to-use solution for the everyday weighing needs up to 2000 kg. Thanks to the 4 load cells, this scale pallet truck is able to guarantee accurate weighing results.

DISPLAY

Its 6 digits LED display provides accurate and precise weighing in kg and lb, and automatic energy-saving shutdown. Weights are shown in 0.5 kg steps with 0.1% precision. Main functions are:

- Tare
- Hold
- Weight totalization
- Zero
- Unit switchable



BATTERY AND BATTERY CHARGER

The PY20 is supplied complete with rechargeable 6V/4Ah battery and charger. The battery module provides 40 hours autonomy.



CONFIGURATION PY20

STANDARD: polyurethane steering wheels and poly tandem rollers



Description

Manufacturer	LIFTER		
Drive	MANUAL		
Lift	MANUAL		
Operator type	Pedestrian		
Load capacity	Q	kg	2000
Load centre distance	c	mm	600
Load axle to end forks	x	mm	938
Wheel base	y	mm	1260

Weights

Service weight	kg	99
Axle load, laden rear	kg	629
Axle load, laden front	kg	1470
Axle load, unladen front	kg	62
Axle load, unladen rear	kg	37

Tyres/Chassis

Tyres: front wheels	POLY		
Tyres: rear wheels	POLY		
Tyre size: Steering wheels - Width	mm	50	
Tyre size: Steering wheels - Diameter	mm	180	
Tyre size: Load rollers - Diameter	mm	70	
Tyre size: Load rollers - Width	mm	70	
Tyre size: rear wheels - Q.ty (X=driven)	nr	4	
Tyre size: front wheels - Q.ty (X=driven)	nr	2	
Tread, front	b10 mm	108	
Tread, rear	b11 mm	380	

Dimensions

Lift height	h3	mm	120
Height of tiller in drive position max	h14	mm	1200
Height of tiller in drive position min	h14	mm	290
Height, lowered	h13	mm	78
Overall length	l1	mm	1640
Length to face of forks	l2	mm	410
Overall width (front/rear)	b1/ b2	mm	540
Fork dimensions - Thickness	s	mm	50
Fork dimensions - Width	e	mm	160
Fork dimensions - Length	l	mm	1150
Forks width	b5	mm	540
Ground clearance, centre of wheelbase	m2	mm	35
Aisle width	Ast	mm	1678
Turning radius	Wa	mm	1350

Performance data

Lifting speed laden	strokes	12
Lifting speed unladen	strokes	12

Scale

Digits	n.	6
Digit height	mm	3
Kilograms		Yes
Lbs		Yes
Tare		Yes
Unbalanced load		Yes
Auto-off		Yes
Totalization		Yes
Accuracy	%	0.1
Load cells	n.	4
Division	kg	0.5
Battery voltage	V	6
Battery capacity	Ah	4

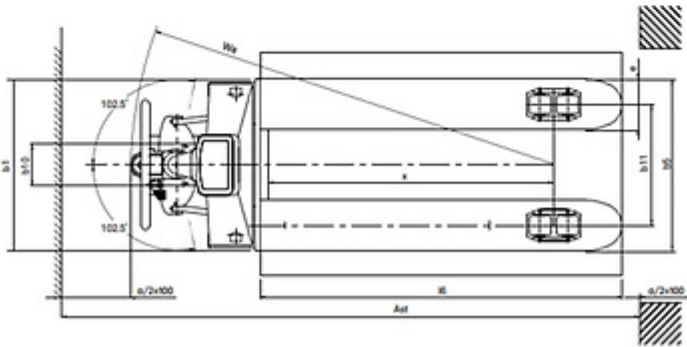
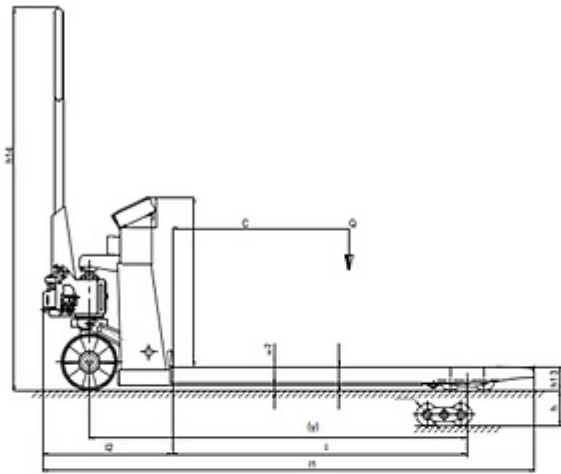

The information is aligned with the Data file at the time of download.
Printed on 22/05/2024 (ID 20991)

©2024 | PR Industrial S.r.l unipersonale - Loc. Il Piano - 53031 Casole d'Elsa (SI) - ITALY.
Company subject to the management and coordination of Generac Power Systems Inc. | All rights reserved | Image shown may not reflect actual package. Specifications subject to change without notice

